

SAFARI 1D1W

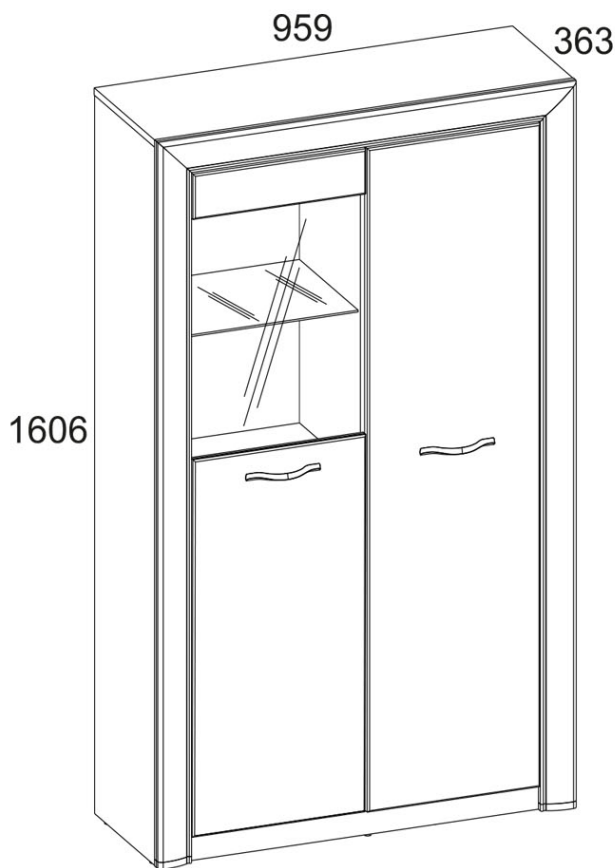

kód	L, mm	B, mm	H, mm		somag
1	958	335	16	1	1/2
2	924	335	16	1	1/2
3	454	335	16	1	1/2
4	454	335	16	1	1/2
5	452	325	6	1	1/2
6	452	335	16	3	1/2
7	1585	335	16	1	2/2
8	1585	335	16	1	2/2
9	1514	335	16	1	2/2
10	924	55	16	2	1/2
11	1464	396	16	1	2/2
13	1464	396	16	1	2/2
15	1587	80	25	1	2/2
16	1587	80	25	1	2/2
17	959	80	25	1	2/2
18	1540	475	2,5	1	2/2
19	1540	475	2,5	1	2/2

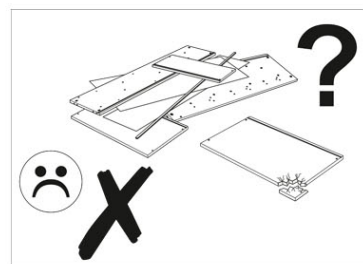

A bűtor használatakor:

- tilos a bűtorokat fűtőberendezések közelében és nedves falak mellett elhelyezni, valamint olyan helyiségekben, ahol a relatív páratartalom meghaladja a 70%-ot;
- a bűtorelemek fűtési hőmérséklete nem haladhatja meg a + 40° C-ot;
- a bűtorok összeszerelése és használata során tilos a vízszintes paneleken és ablakokon állni;
- tilos a vegyi tisztítószer használata a bűtorok tisztításához;
- nem szabad víznek kitenni.

Illat.

Az új bűtorok azon anyagok szagát árasztják, amelyekből készültek. A szag az összeszerelés után akár három hétig is megmaradhat. Az illat intenzitásának csökkentése érdekében ajánlott:

- kárpitozott bűtorok esetén - kiporszívózni a terméket és kiszellőztetni a helyiséget.

Ismételje meg naponta 3-4 alkalommal.

- szekrénybűtorok esetén - törölje le enyhe tisztítószerrel megnedvesített ronggyal, majd törölje le tiszta, száraz ronggyal és szellőztesse ki a helyiséget, de először nyissa ki a termék összes ajtaját és fiókját.

Ismételje meg naponta 3-4 alkalommal. Fontos! Kérjük, őrizze meg az utasításokat, hiszen szüksége lehet rájuk a bűtorok ismételt összeszerelése vagy reklamáció esetén. Panasz benyújtásakor kérjük, használja a kézikönyvben található jelöléseket.

FIGYELEM! Egy bűtordarab leesése súlyos vagy halálos sérüléseket okozhat. **MINDIG** rögzítse ezt a bűtordarabot a falhoz a rögzítőelemekkel. A beágyazott csapot téglá- és betonfalakhoz használják. A falra szereléshez a fal anyagának megfelelő rögzítőelemeket használjon, ha nem biztos abban, hogy a fal





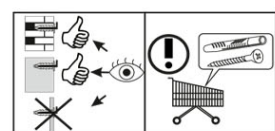
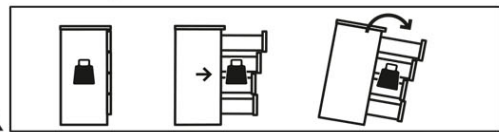

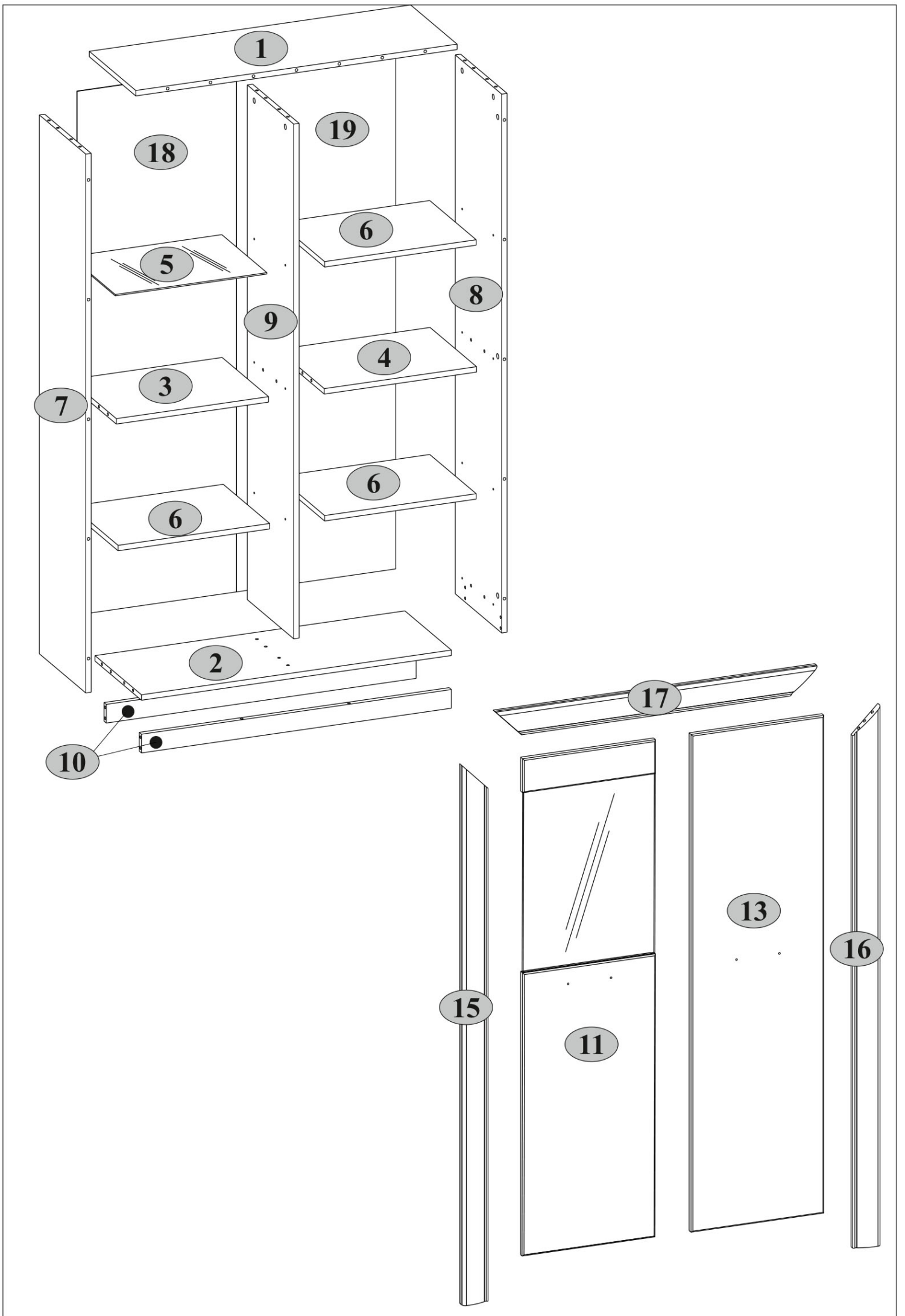

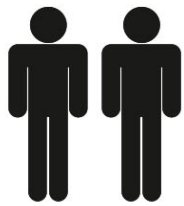





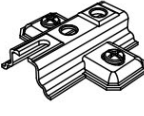
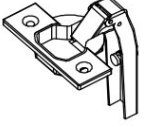





anyagához milyen rögzítési mód megfelelő, forduljon szakemberhez vagy látogasson el egy szaküzletbe. A rögzítőelemekért végső soron a szerelő a felelős. A bűtor felborulása miatti súlyos testi sérülések és halálesetek kockázatának további csökkentése érdekében:

- A legnehezebb tárgyakat helyezze az alsó fiókba.
- Ne helyezzen nehéz tárgyakat rá.
- Soha ne engedje, hogy a gyerekek felmásszanak a fiókokra, ajtókra vagy polcokra.
- A bűtorokat rendeltetésszerűen használja





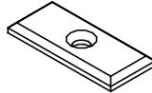

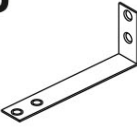
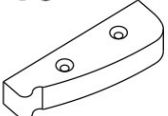

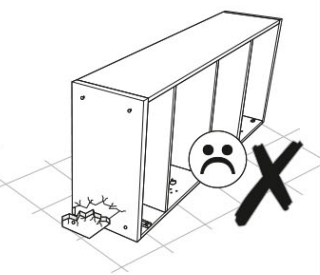
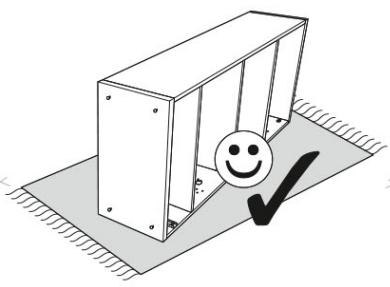
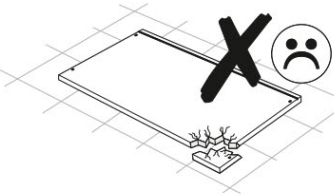
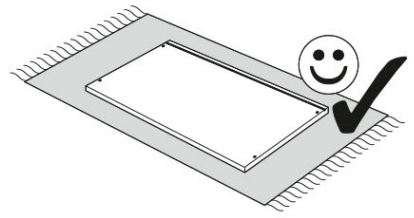
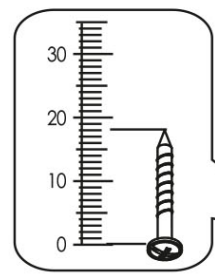
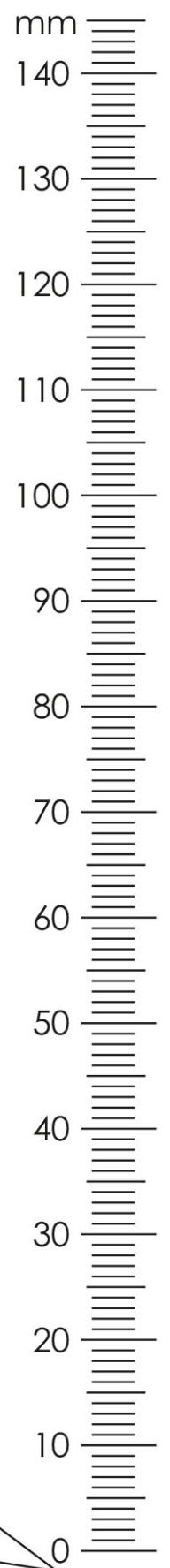
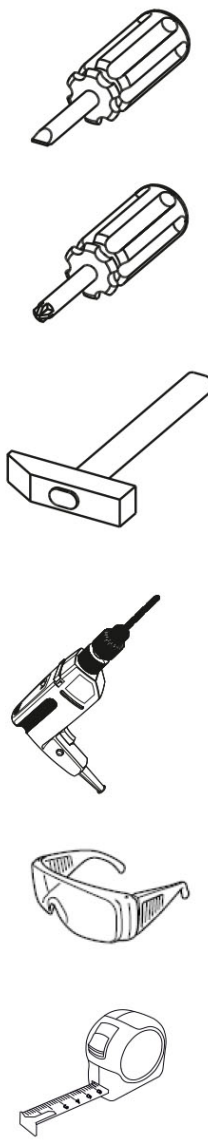



A1.0  5x28 28	A2  15x13 32	A9  L-47,4 2	B5  10x50 1
C1  8x35 43	D1  6	E2  6	G  1,5x26 40
H63  2	I  S4 1	M4  M4x22 4	N1  6
P1  Ø5 12	P4  4	Q  1,5x7 4	R3  3x20 5
R5  3x30 4	R23  6,3x13 12	R24  7x50 2	R102  3,5x16 14
S3  5	S5  Ø18 16	U  130x35x15 1	V16  80x25x15 2

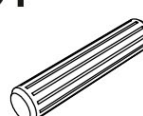



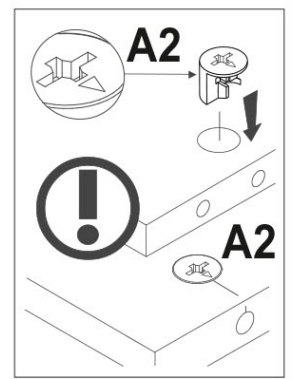
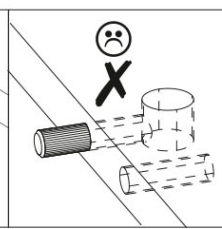
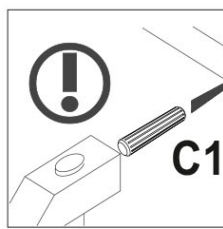
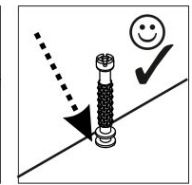
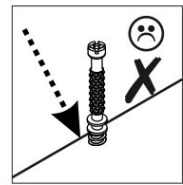
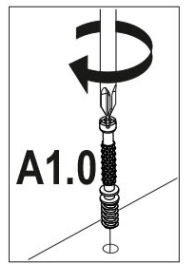
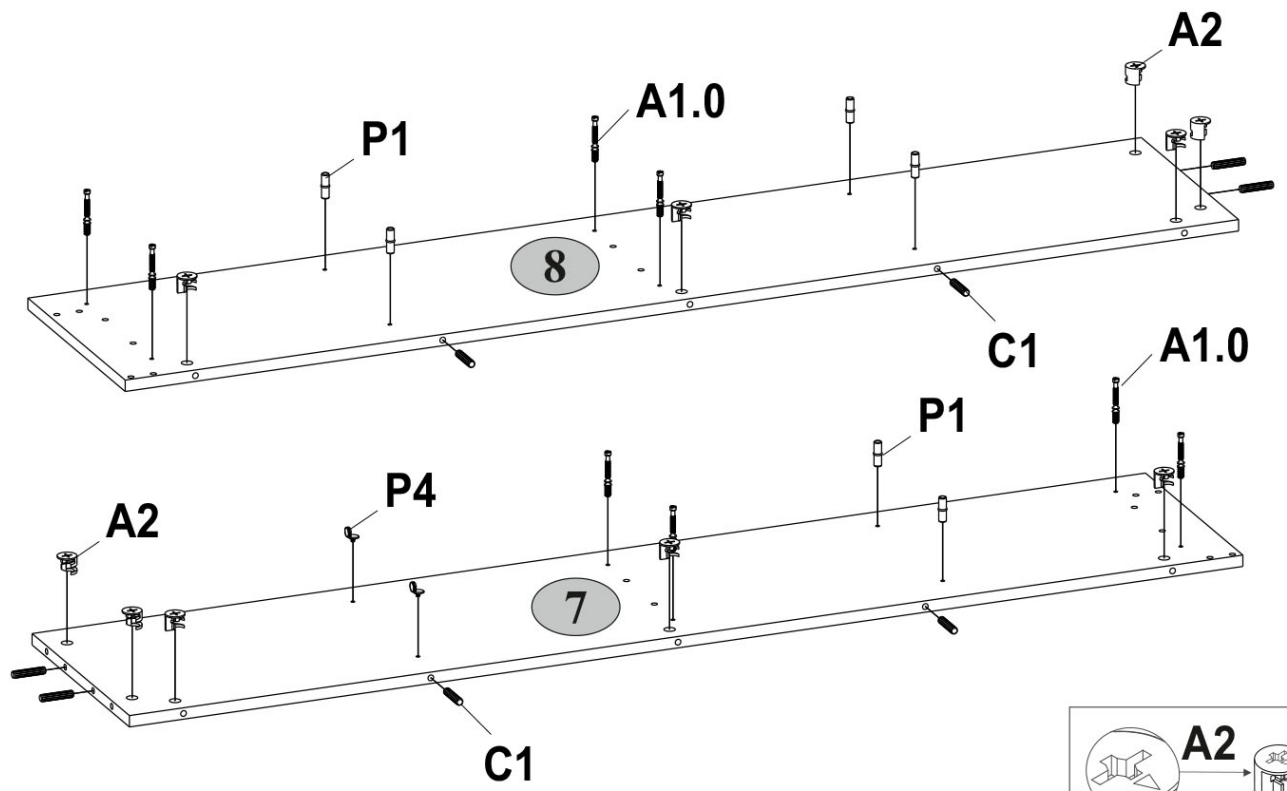

1

A1.0  5x28	A2  8 15x13	C1  10 8x35	P1  8 Ø5	P4  6	P4  2
--	---	---	---	---	---





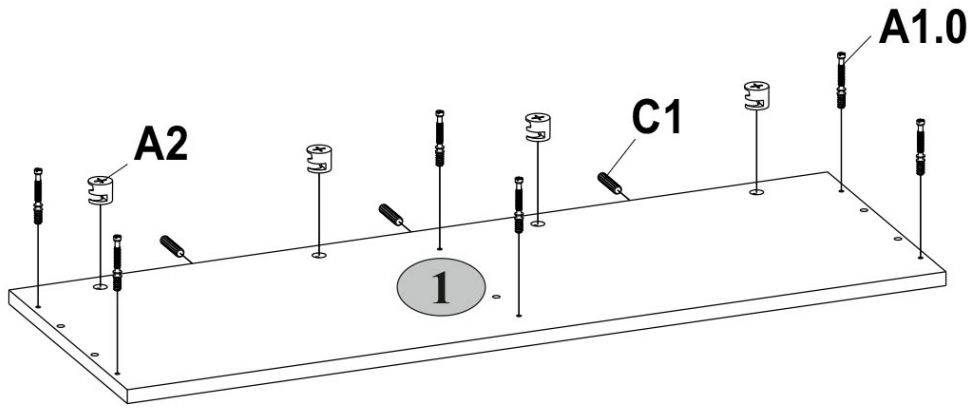

2

A1.0  5x28	A2  6 15x13	C1  4 8x35	C1  3
--	---	--	---



3

A1.0  5x28	A2  4 15x13	C1  2 8x35	P1  4 Ø5	P4  6 2
--	---	--	---	---

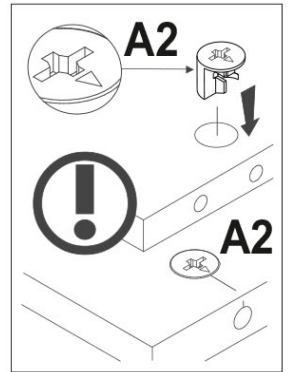
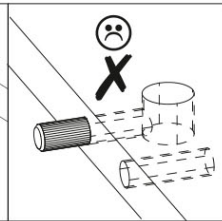
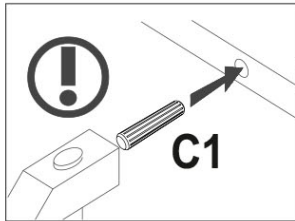
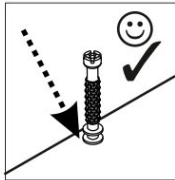
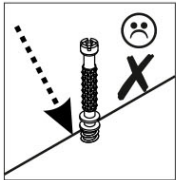
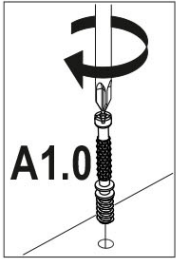
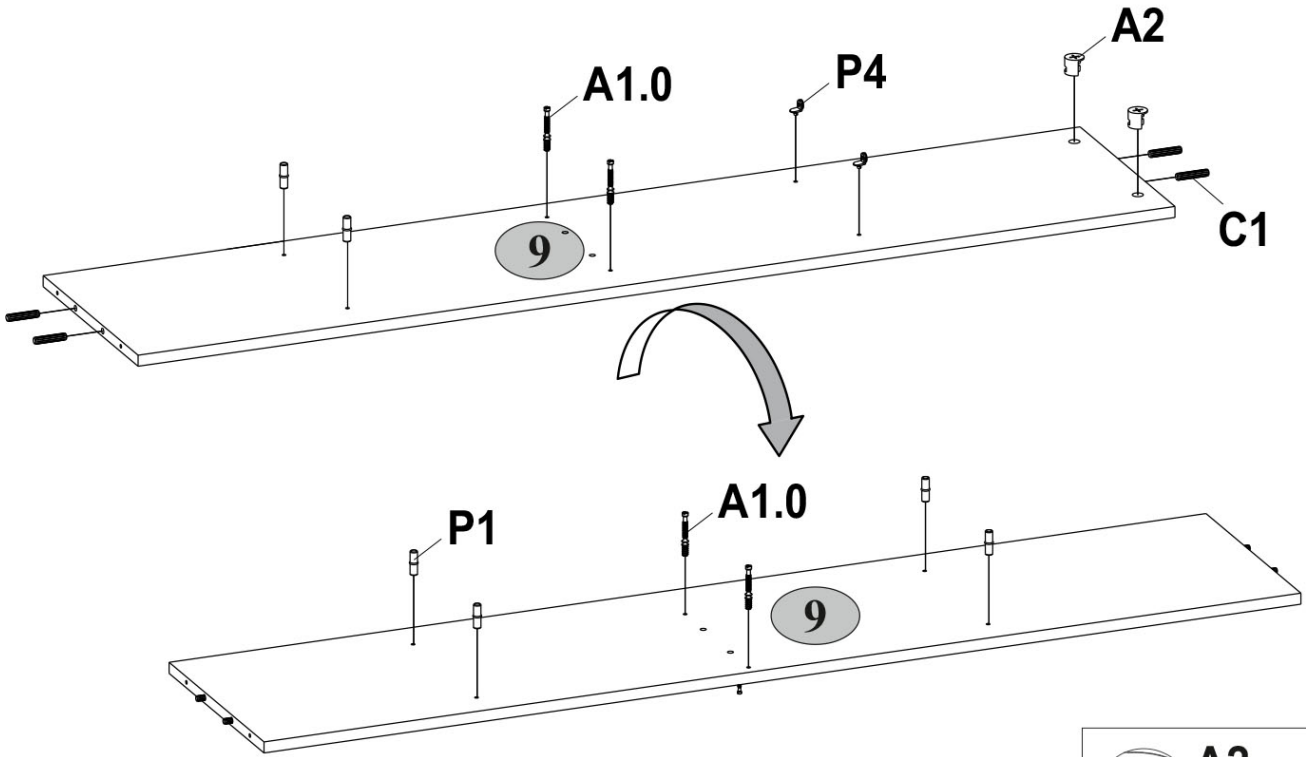

4

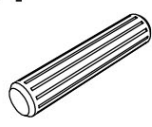
A2  15x13	C1  8 8x35
---	--

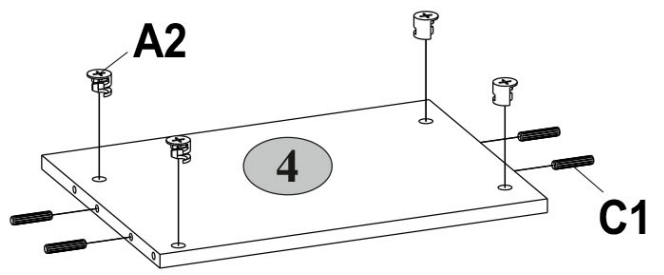
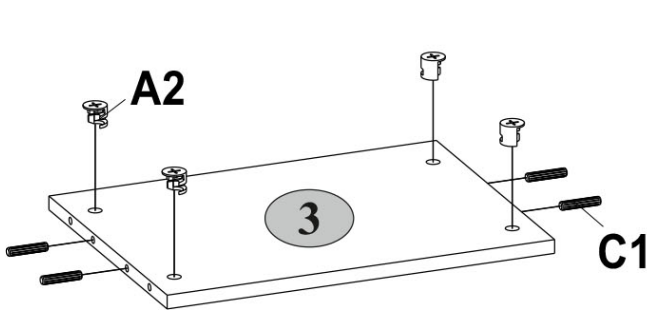

5

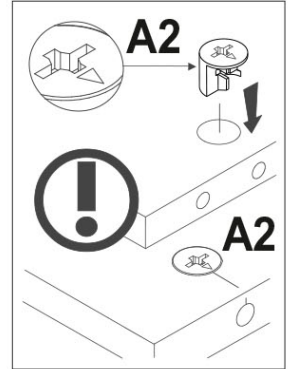
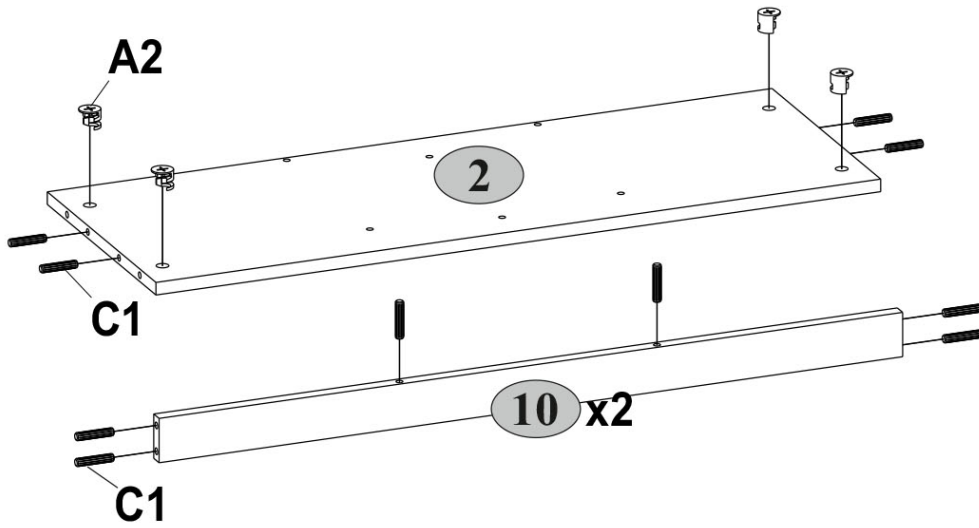
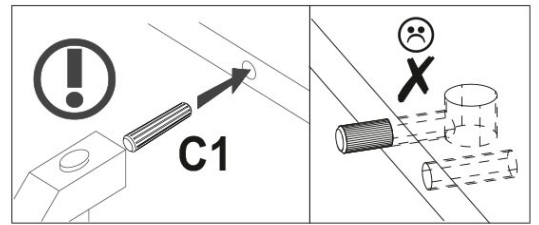
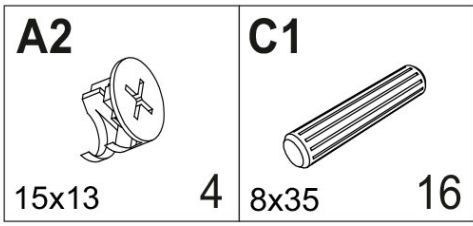

6

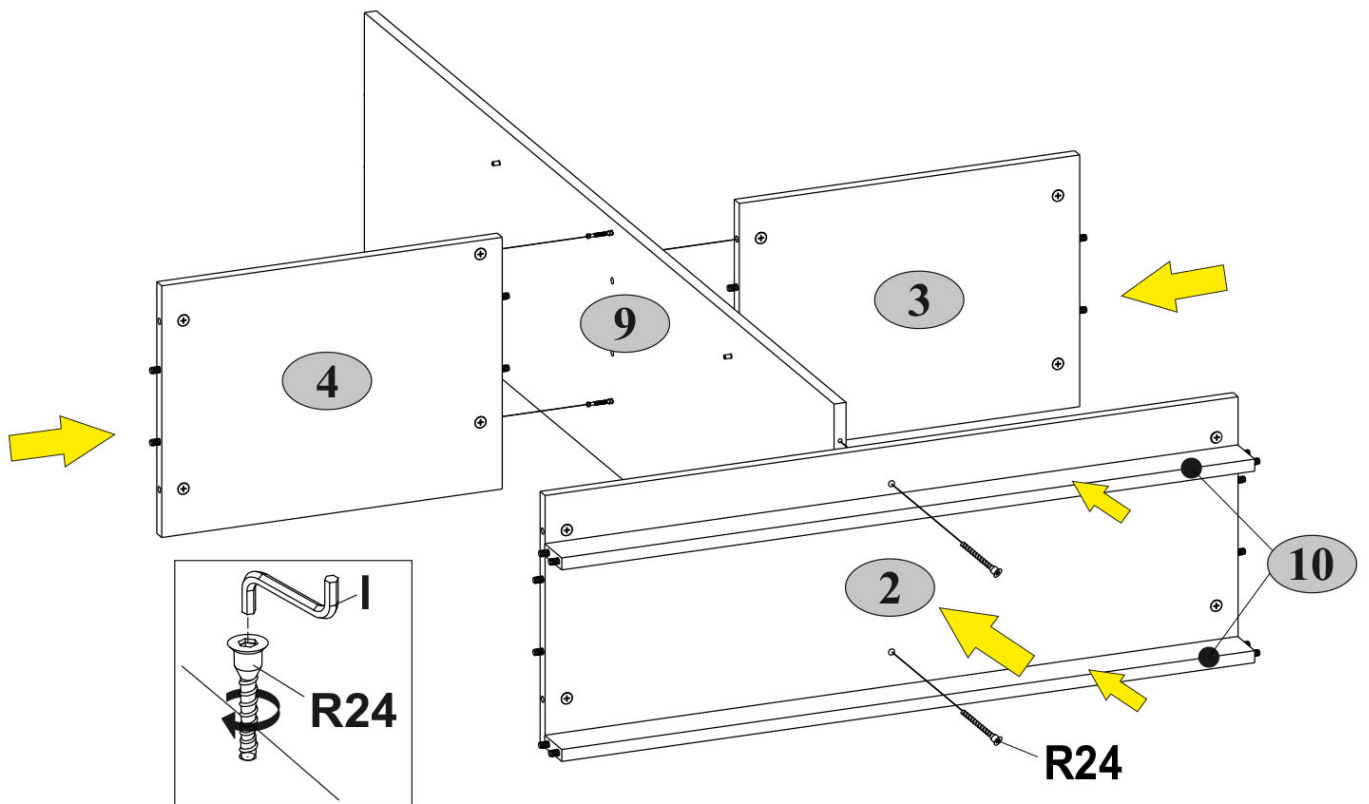
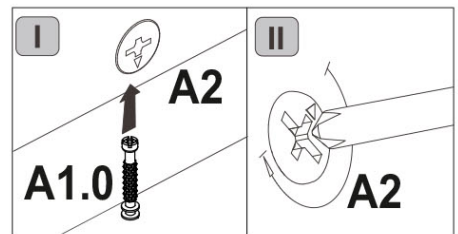
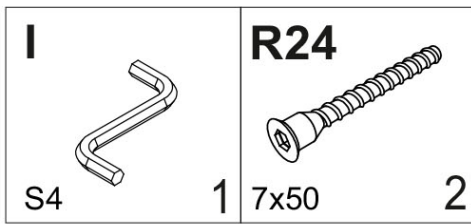

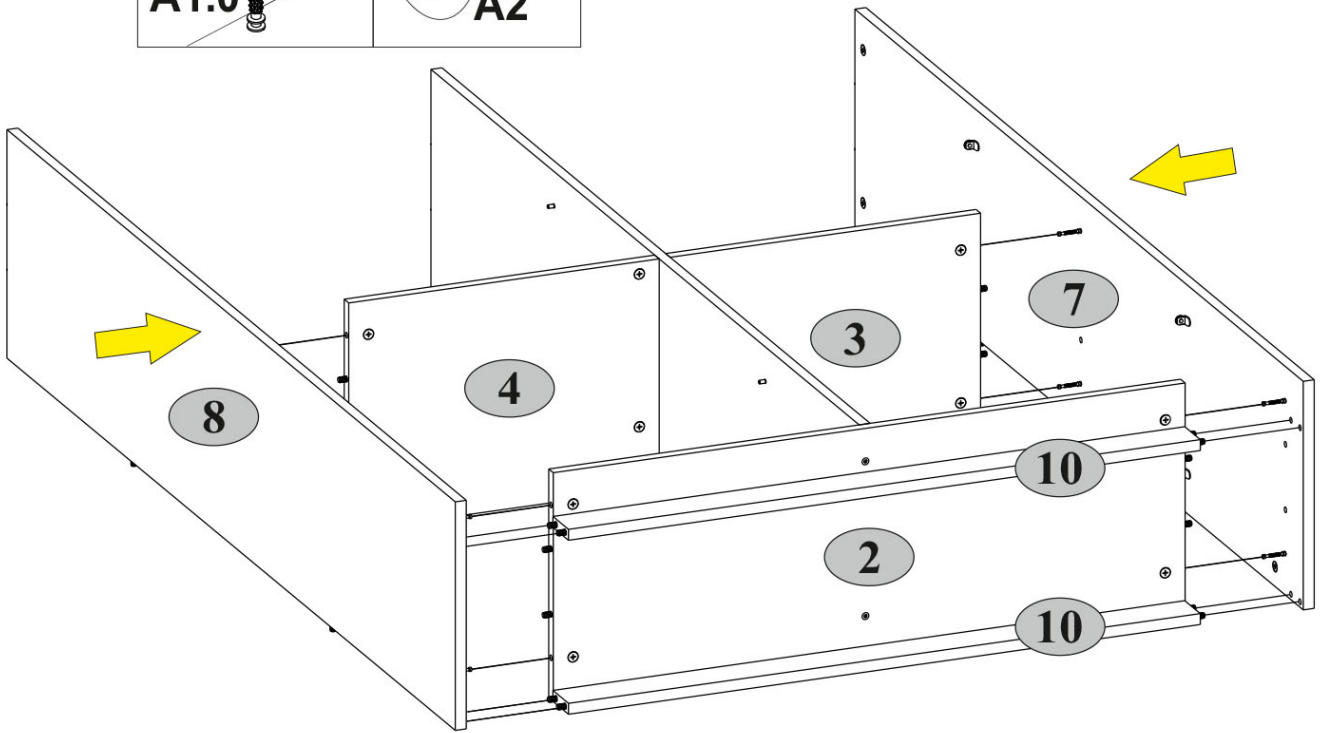
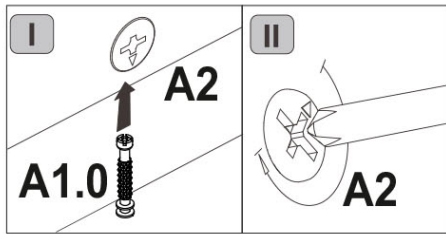

7

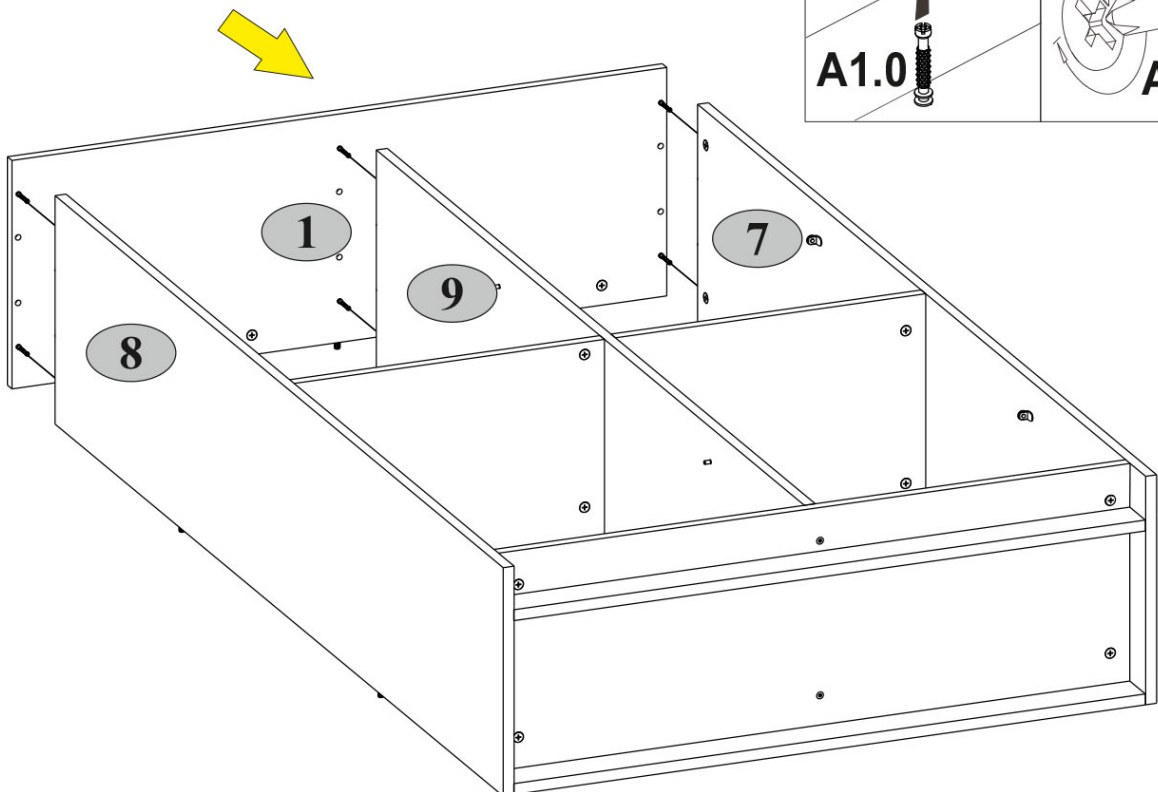
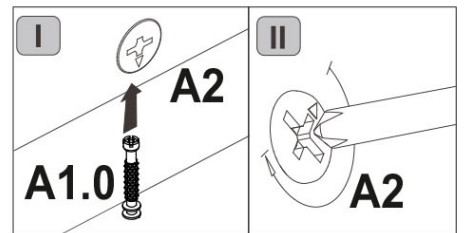

8





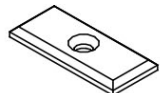

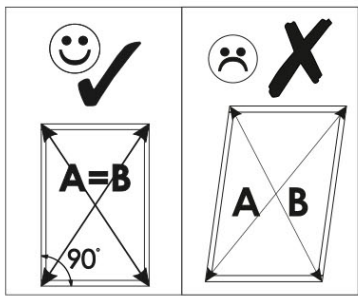
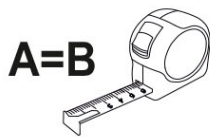
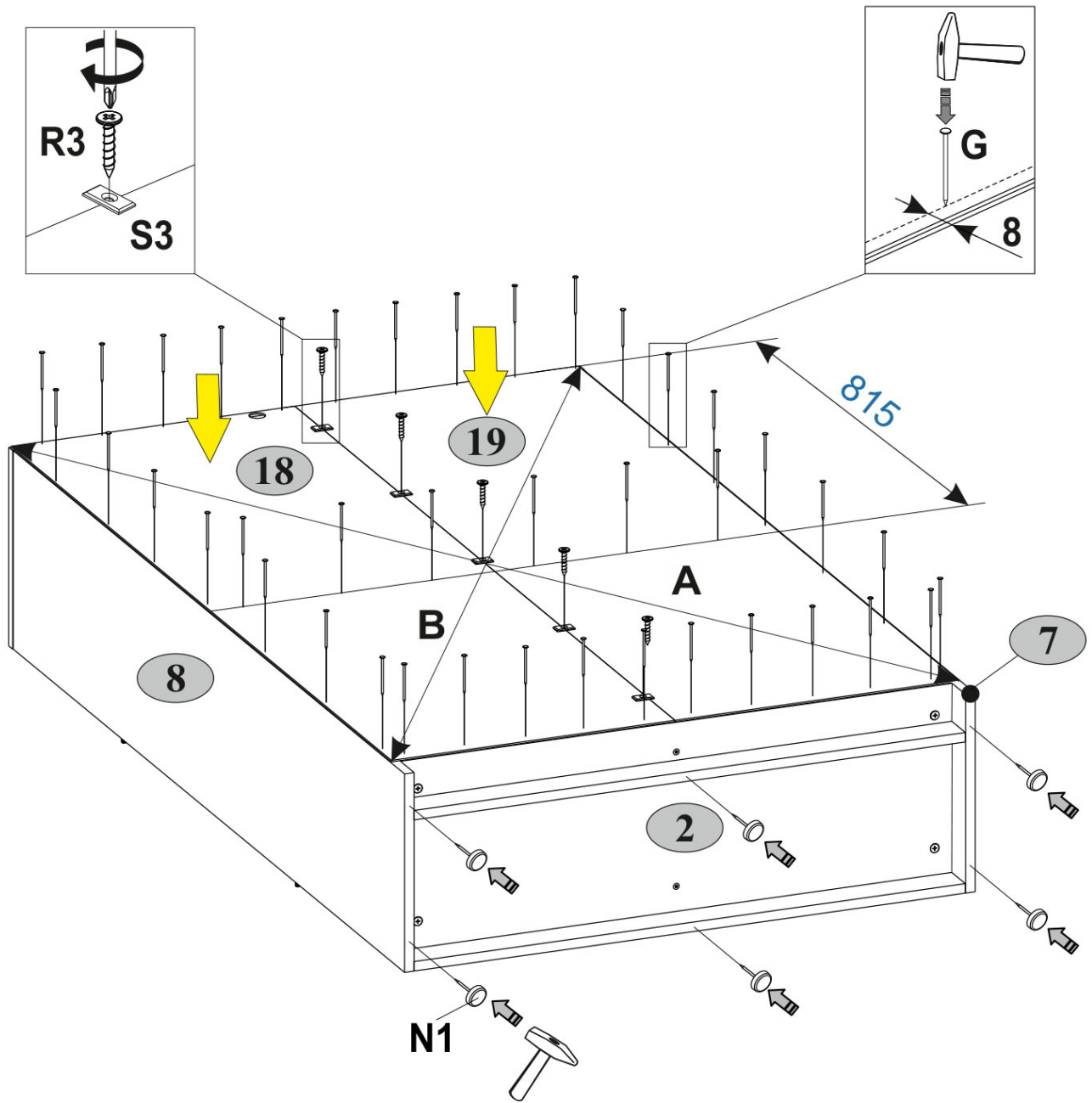
9

G  1,5x26 40	N1  6	R3  3x20 5	S3  5
---	---	---	--



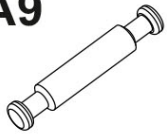
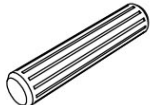
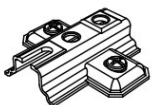

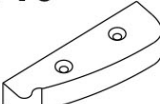

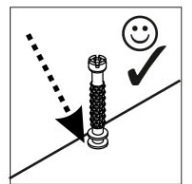
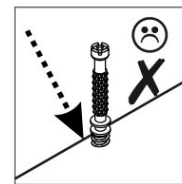
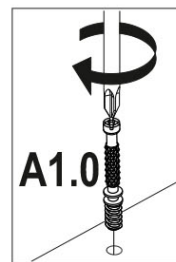
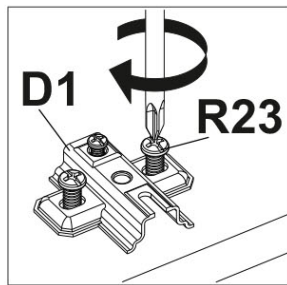
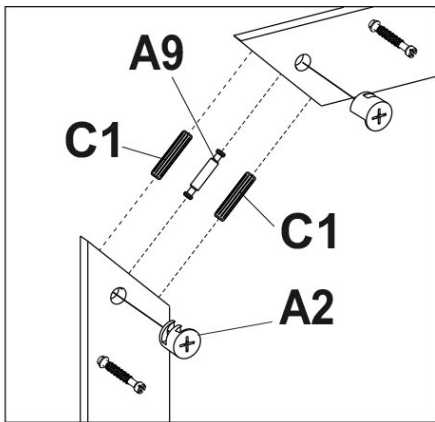
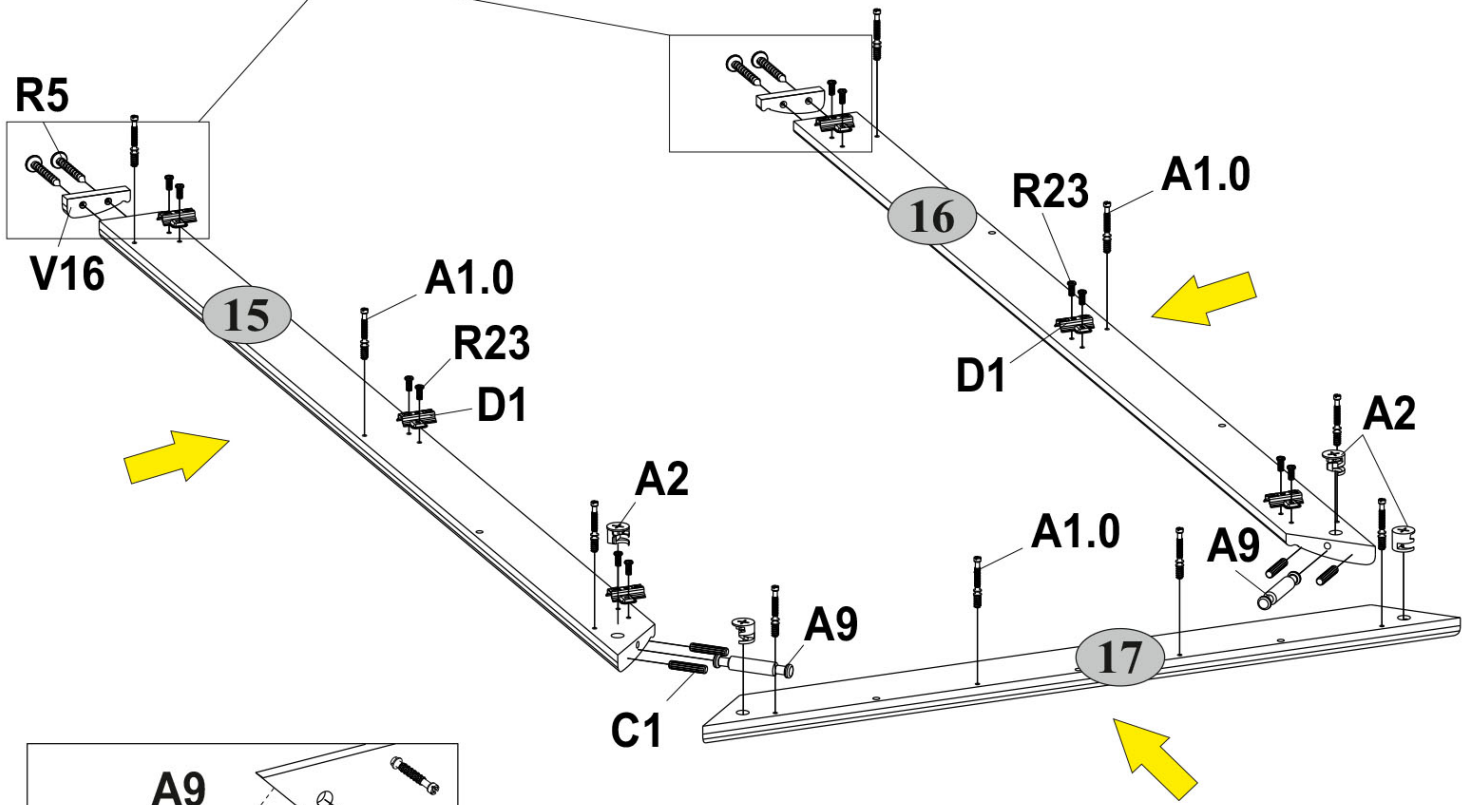
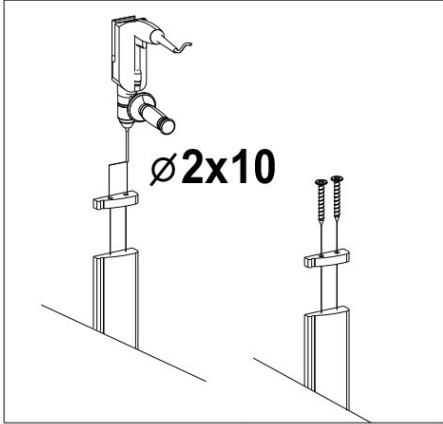
10

A1.0  5x28 10	A2  15x13 4	A9  L-47,4 2	C1  8x35 4	D1  6
R5  3x30 4	R23  6,3x13 12	V16  80x25x15 2		

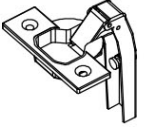

11

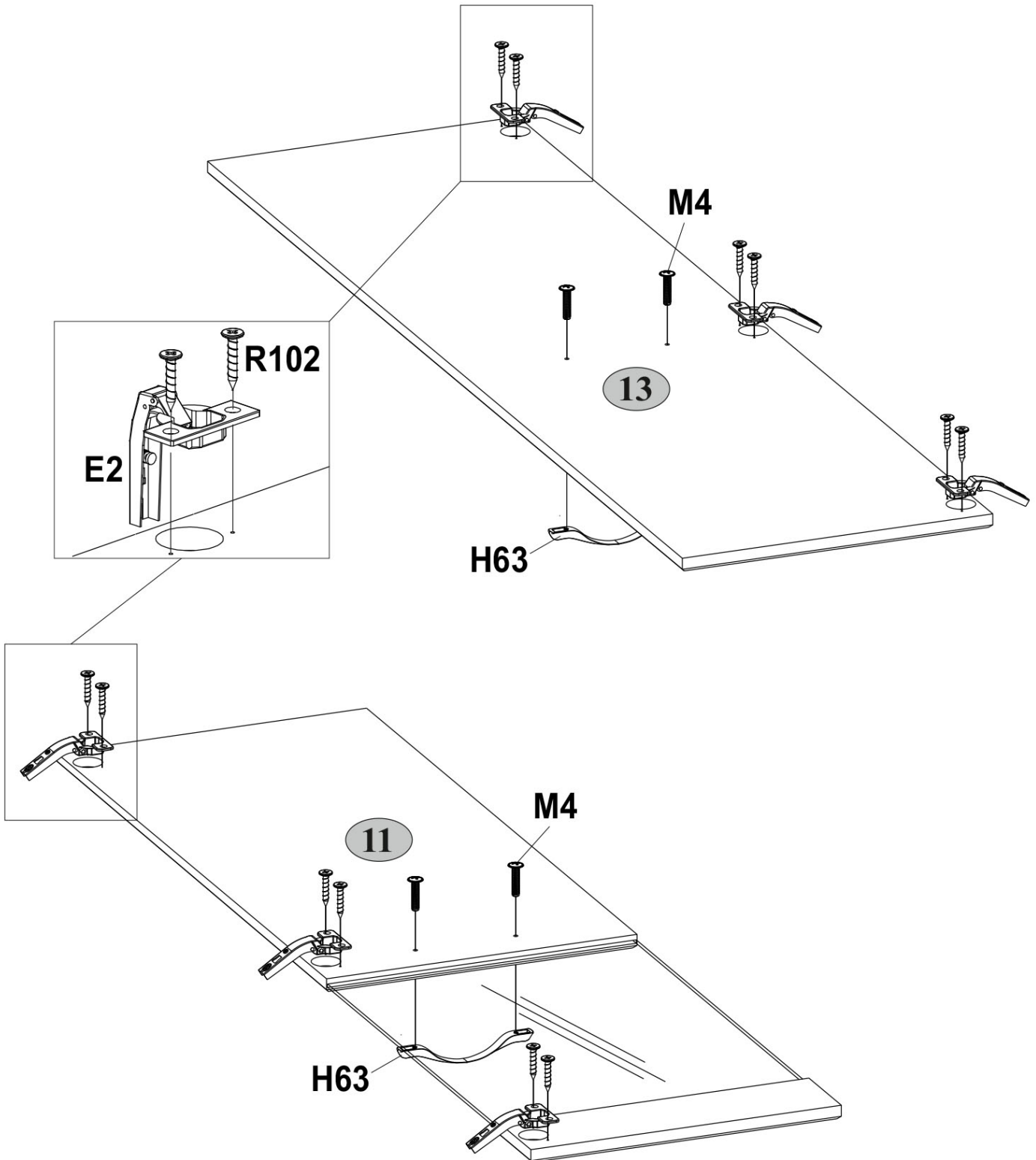

E2  6	H63  2	M4  M4x22 4	R102  3,5x16 12
---	--	---	---



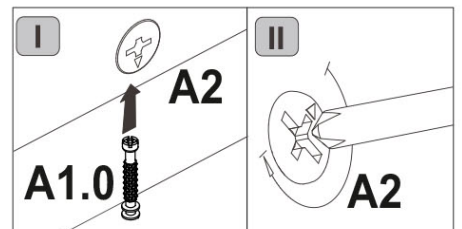
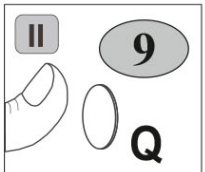
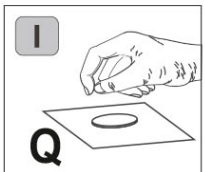
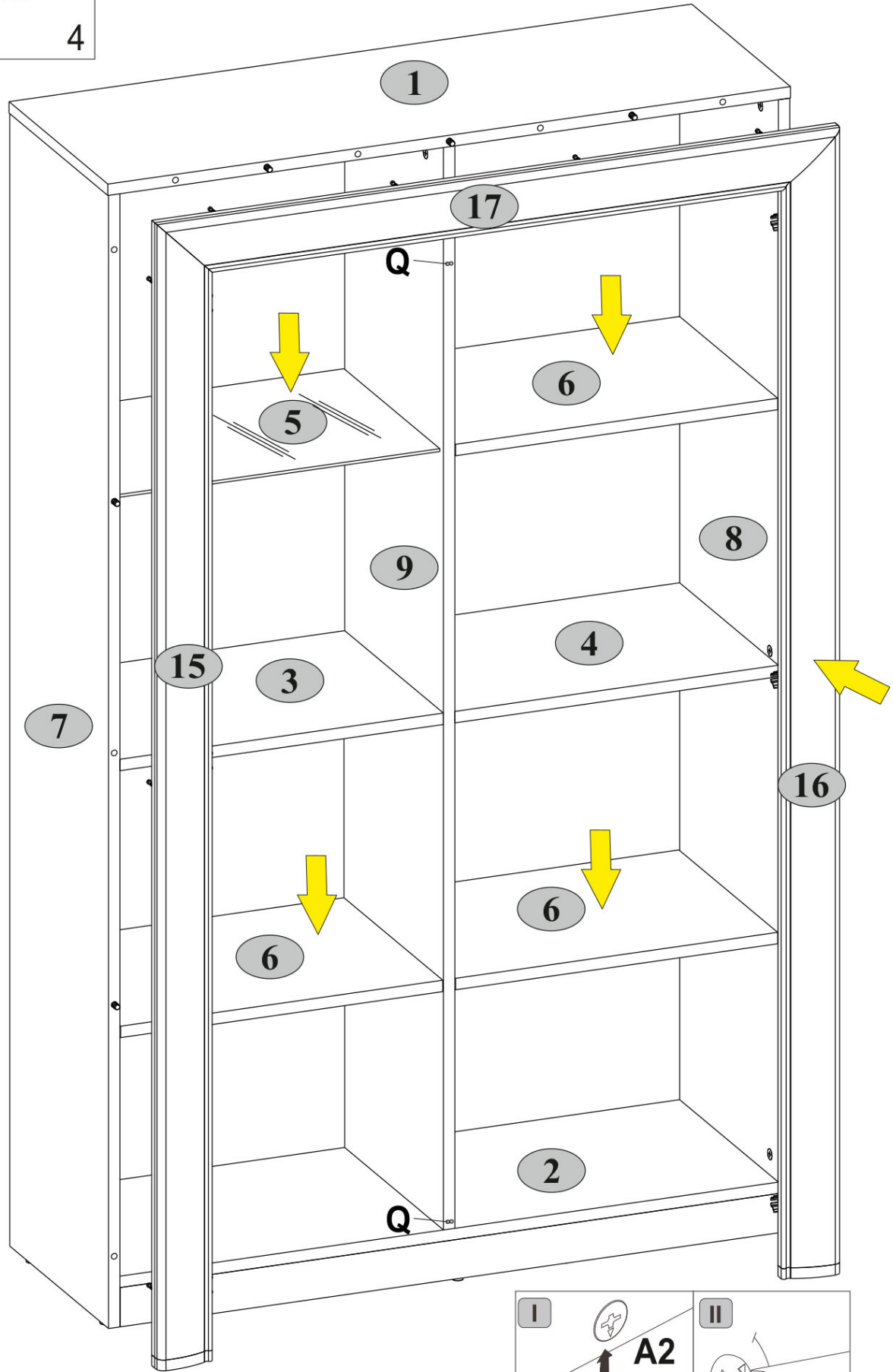
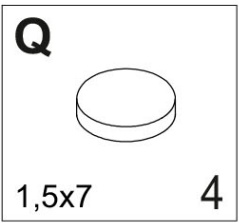



12

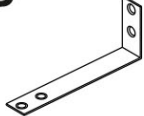

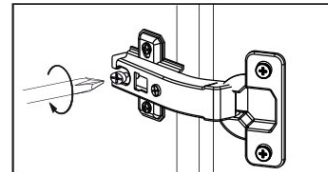
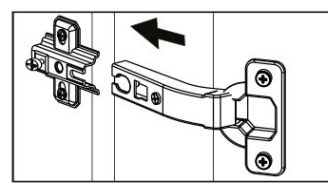
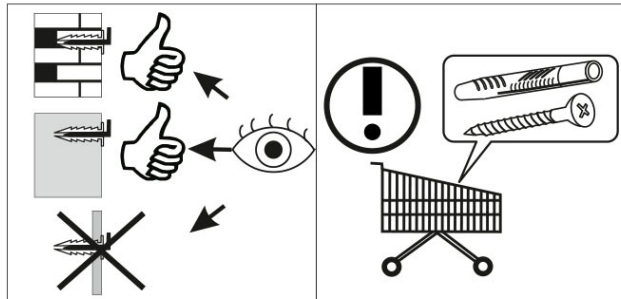
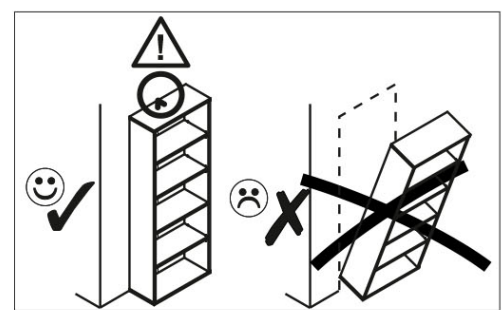
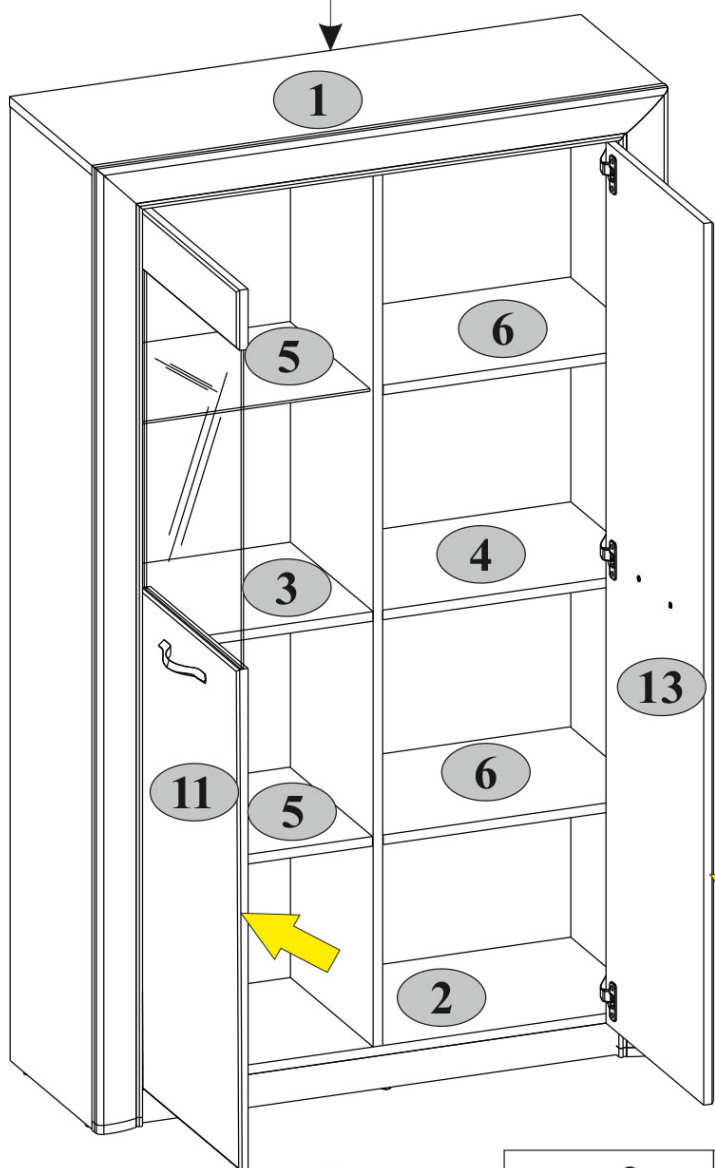
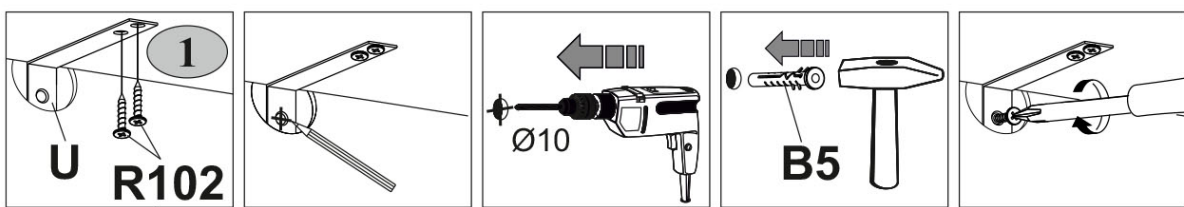
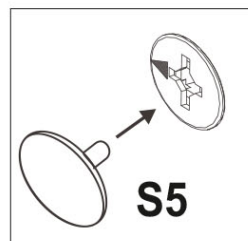
13

B5  10x50 1	R102  3,5x16 2	S5  Ø18 16	U  130x35x15 1
---	--	--	---



- 3 4 5 6**  max. 5 kg
- 1**  max. 10 kg
- 2**  max. 15 kg

